

EC-135

ACE Smart RC Helicopter

User Manual

2025.11



Reading Tips

Description of symbols



IMPORTANT



INSTRUCTIONS FOR OPERATION AND USE

Instructions for use of the product

It is recommended that the user first watch the instructional video and the User's Manual to understand the detailed use process and flight safety-related contents of the product. The product is then used safely in a compliant location.

Get instructional videos

Users can click on the links below or scan the QR code to view instructional videos to ensure proper and safe use of the product.

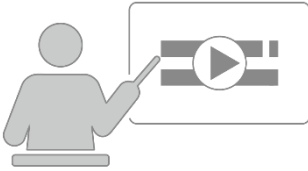

Official website



Youtube



TikTok

Download adjust software

The user can download the ACE flight control parameter adjustment software at the following address:

<https://www.flywingrc.com/downloadCenter>



The operating ambient temperature of this product is -10°C to 40°C , which does not meet the requirements of military grade (-55°C to 125°C) requiring higher adaptation conditions according to the classification of applicable temperature of electronic components. Use the helicopter properly in an environment that meets the use scenario.

* To ensure flight safety, please comply with local laws and regulations.

Table of Contents

Product Overview

Product Use Instructions	4
First-time use	4
Prepare the helicopter	5
Preparing the Remote Control	5
Outdoor Flight	6
Function Introduction	8
One-Key Return	8
Low Battery Return	8
Compass Calibration	9
Coordinated Turn	10
Three flight sensitivities mode	10
Soft Take-off/Land	11

Flight safety

Pre-Take-off Inspection	11
Safety Summary	11
Disclaimer and Warning	13

Appendices

How to switch the sticks modes (M1/M2)	14
Advanced Parameter Explanations	14
LED flight status indicator	15

Product Overview

Instructions for use of the product

The Flying EC-135 ACE scale Helicopter is equipped with multi-link GNSS system, supporting GPS/BDS/GLONASS/GALILEO and other positioning systems. Hover stably outdoors and support one-button return/low battery return. Hover outside without wind, maximum flight time is about 18 minutes*.

The Flying EC-135 ACE intelligent stunt helicopter adopts the customized 2.4G transmitter, which can achieve the remote control transmission with the maximum communication distance of 1KM* in the non-interference and non-blocking environment. If the transmitter signal is lost too far away, the helicopter can return autonomously. During the return process, the return can be canceled by switching the return switch, and the helicopter can be taken over manually.

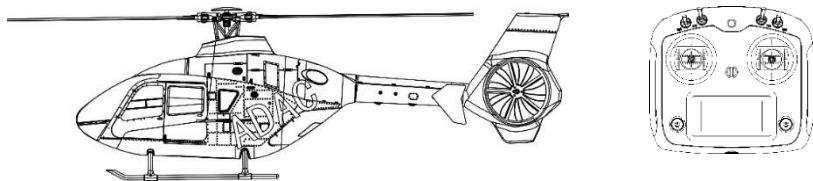

- * The maximum flight time of the helicopter is measured when the helicopter hovers in a windless environment at sea level until the remaining power is zero. It is for reference only. Please pay attention to the flight control indicator or return status during actual flight.
- * The maximum communication distance is the maximum communication distance (one-way non-return) that can be reached by the remote control equipment under the FCC standard when flying in the environment without shielding and electromagnetic interference, and the flying altitude is about 120m.



This helicopter has no relevant flight restrictions. Please use this product in accordance with local regulations.

First-time use



Visit the link or scan the QR code to watch instructional videos.



Prepare the helicopter

The flight battery needs to be charged for the first time. Connect the supplied charger to the battery plug, turn the charger mode switch to Charge mode, and connect to AC power to start charging. When 99 is displayed on the screen, the battery is fully charged.

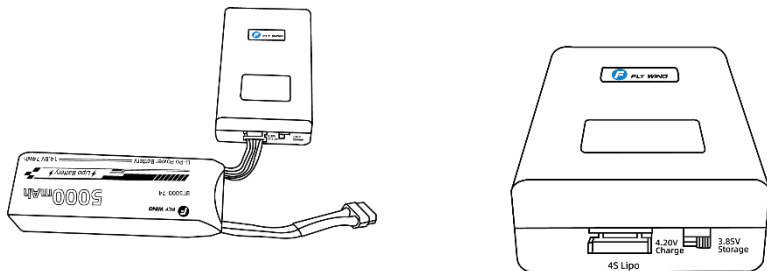

If the battery is not used for more than 5 days, it is recommended to use the storage mode of the charger to save the battery, and check the operation once every month.

Preparing the Remote Control

To use the remote controller for the first time, open the battery compartment cover on the back of the remote controller, prepare 4 AA batteries of No. 5, move all the toggle switches to the uppermost side, and press and hold the two power buttons for 5 seconds to complete the startup.

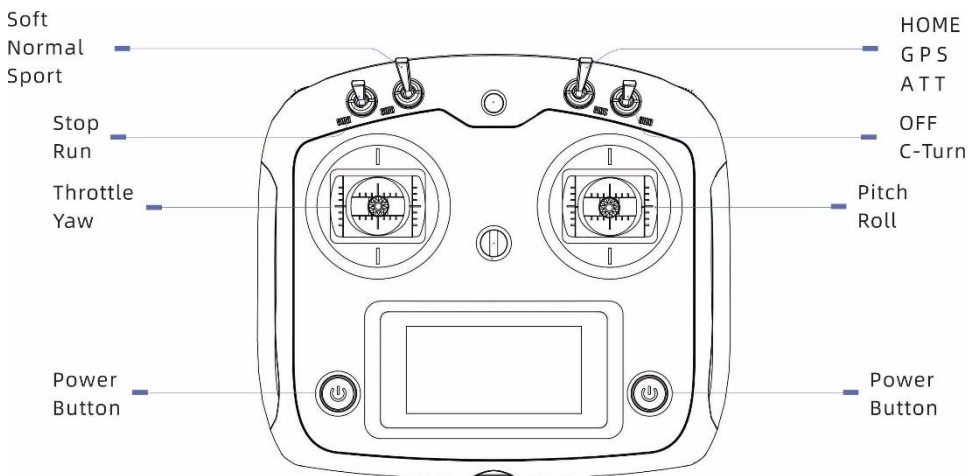

Outdoor flight

1、 Insert Blades

Insert the blade with its sharp edge facing up into the rotor holder; rotate the blade 90° clockwise, then pull it outward to confirm the spring snaps back.

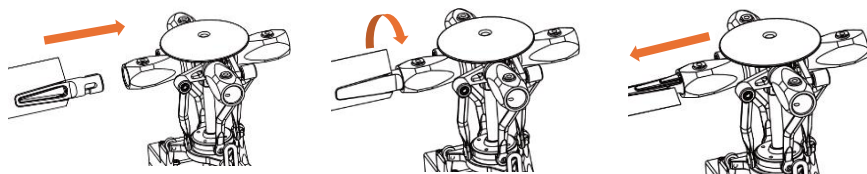

2、 Powering Up the helicopter

After switching on the transmitter, pull down the latch to open the front canopy. Secure the battery to the wooden base plate inside. Plug the yellow XT60 battery connector into the ESC to power the helicopter. Close the canopy, set the model on the ground, and keep it motionless while the servos move to complete the self-test.

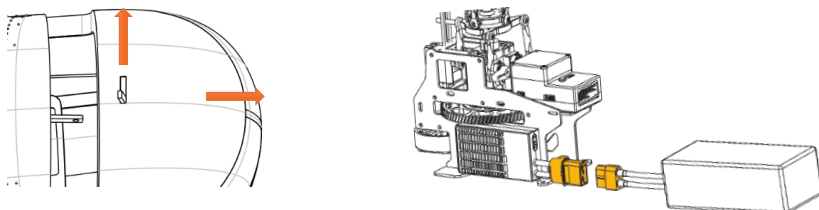

3、 Inspection before takeoff

Set the remote controller to GPS mode, place the helicopter in an open area, and wait for satellite lock. When the green light stays solid, grasp the helicopter and rotate it 360° horizontally; watch whether the LED turns yellow or red. If the green light remains solid, the compass is normal and you can take off (wait one minute after the green light appears so the home point refreshes more accurately). If the LED flashes yellow or red at any angle, recalibrate the compass (see Compass Calibration section). Next, move the sticks to check that the servos travel correctly and that the mechanics are free of binding or damage. When everything is verified, you are ready to lift off.

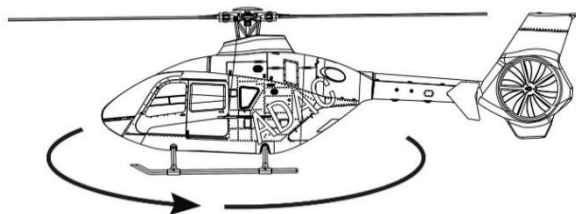

3、Take-off

Ensure that the remote controller is in GPS mode and the helicopter is in an open field. Observe the flight environment. After confirming that it is normal, the flight control is unlocked and the green light flashes. During the flashing period, turn the start/stop switch to the start position, and the helicopter begins to accelerate slowly; Wait for about 10 seconds, the helicopter speed is stable, push the ascending and descending rocker for 1 second, and then the helicopter takes off; Release the rocker and hover the helicopter.

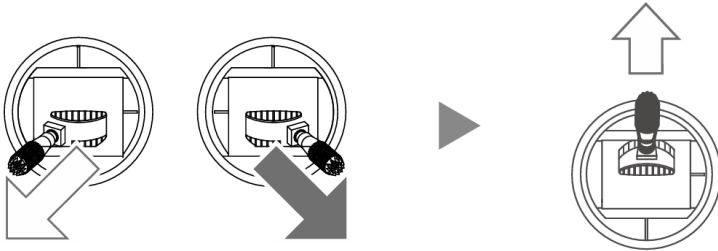

Attitude control:

Take Mode2 (left-hand throttle) as an example.

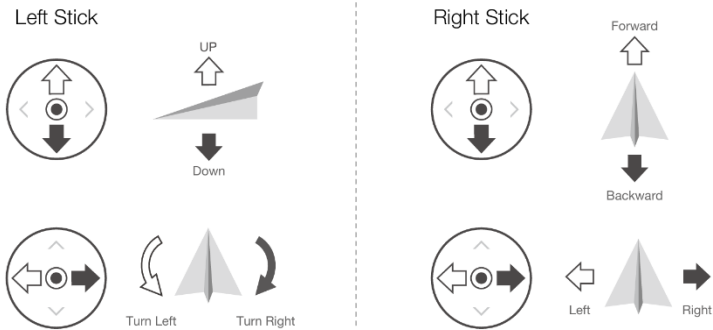

4、Landing

Ensure the helicopter is above an open area. Survey the flight environment and confirm normal conditions. Gradually pull the throttle stick downward without engaging the lowest position—the helicopter will descend slowly until it touches the ground. After a stable and steady landing, toggle the motor start/stop switch to the cut-off position, then gently release all control sticks and wait for the rotors to come to a complete stop.

Function introduction

1、One-Key return

Ensure that the helicopter is above the open field, observe the flight environment, after confirming that it is normal, turn the return switch to return, all indicator lights of the flight control will turn purple and remain on (flight control indicator and external LED lamp panel), and select different return modes according to the distance from the take-off point:

Within 10m from the current position to the return point:

- When the front altitude is less than 5m, rise to 5m and return.
- When the current altitude is greater than or equal to 5m, return at the current altitude.

The current position is more than 10 meters from the return point:

- When the front altitude is less than 15m, return to the altitude of 15m.
- When the current altitude is greater than or equal to 15m, return at the current altitude.



The return point is the position where the helicopter unlocks the take-off position. The accuracy of the return depends on the satellite quality of GPS during the takeoff. When the satellite quality is good, the error of the return point is about 2m. It is recommended to wait for one minute after the flight control green light is normally on before takeoff to allow the satellite signal to stabilize before unlocking the takeoff. When the helicopter starts to land above the return point, the landing point can be finely adjusted through the remote controller, and the remote controller cannot operate the helicopter during the return process.

2、Low battery return

EC135-ACE supports 4S Li-Po battery. Built-in two-stage voltage protection mechanism. When the battery power of the helicopter is low, the helicopter will automatically trigger the low battery protection, and then the indicator light will give an alarm, and return is triggered after about dozens of seconds. Refer to one-key return for the return mode.

When using a 4S Li-Po battery:

- When the battery voltage is lower than 15.2V, it is forbidden to unlock the helicopter.
- When the battery voltage is less than 14.77V, the helicopter triggers a level I charge alarm. At this time, all indicator lights of the helicopter will flash slowly in purple.
- When the battery voltage is lower than 14.73V, the helicopter triggers the primary power return. All helicopter indicators will be solid purple. and triggers the first return voltage. At this time, the user can cancel the return voltage by switching the return voltage switch to the return voltage, and then switching the switch to close the return voltage. All indicators will flash yellow-green (yellow-blue flash in ATT modes).

- When the battery voltage is less than 14.6V, the helicopter triggers a secondary battery alarm. All helicopter lights will now flash back to purple.
- When the battery voltage is lower than 14.53V, the helicopter triggers the secondary power return. All helicopter indicators will be solid purple. and force a second return. At this point the user cannot cancel until the helicopter returns and lands.

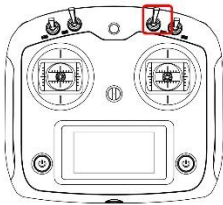

3、Compass calibration

Please select an open area and follow the steps below to calibrate the magnetometer. For additional guidance on compass calibration, visit our official website www.flywingrc.com to watch video tutorials.

Method 1: Calibration with Remote Control

- Put the flight mode switch of the remote controller in the Home mode, then quickly dial to the ATT mode, and then dial back to the Home mode, repeat above 3 times, and finally stay in the Home mode; Wait a few seconds and the GPS light begins to flash red and enter the magnetometer calibration state.
- Roll each face of the helicopter for at least 2 circles, the status light of the flight control will gradually change from red to green. Finally, when the flight control light is normally on and then off, the calibration is completed, and the flight control will restart automatically; When restarting, the LED lights flash red quickly, then turn off for a few seconds, and finally flash red and blue quickly, and the restart is completed.

Flight control LED: red-green flash-yellow flash-blue flash-green flash-green-steady green-automatic restart

External LED: red light is always on---orange light is always on---yellow light is always on---green light is always on---automatic restart

During the restart, the helicopter must be placed on the ground and held still, waiting for FCT (do not hold the helicopter in hand).

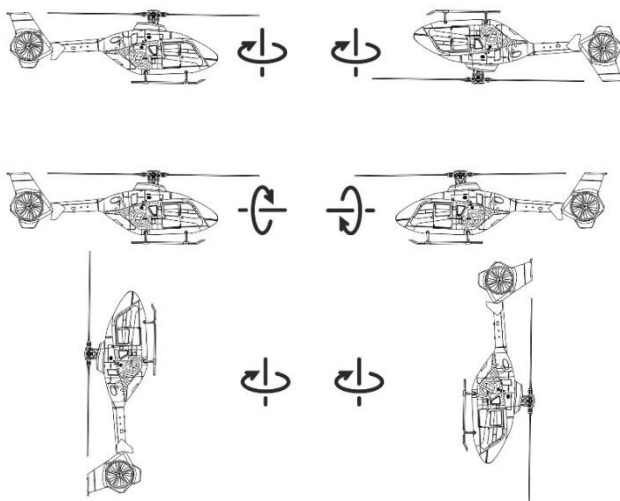

4、Coordinate turning

When the C-Turn function is turned on in EC135-ACE, the YAW stick is used for turning. The flight controller will automatically increase the aileron roll control based on the current flight speed, helping the helicopter turn with a smaller radius and achieve a more realistic turning posture.



This function is valid by default in GPS mode and ATT mode.

5、Three Flight Characteristics Mode

The helicopter has built-in three flight sensitivities, which can be switched by the remote control switch.

- In the soft mode, the maximum flight speed, maximum flight angle and reaction speed of the helicopter will be limited. This mode is very suitable for the novice to operate the helicopter.
- Under the normal mode, the maximum flight speed, the maximum flight angle and the reaction speed of the helicopter are faster than the soft mode, and the mode is very suitable for daily helicopter flight.
- In the sport mode, the maximum flight speed, maximum flight angle and reaction speed of the helicopter will all reach the maximum flight control value. At this time, the helicopter is very flexible and the flight speed is very fast. It is recommended that experienced players use it in an open field.

6、Soft take-off/landing

When the helicopter takes off and lands, the flight control takes over the vertical velocity completely, and when the altitude reaches 1 m, it switches to the proportional control of the remote controller. It can solve the problem that the helicopter takes off too fast. During take-off, except for the throttle lever, other rocker directional controls are not affected. (Since the distance from the ground is estimated by the barometric pressure, there may be some error in windy weather.)

Flight Safety

Pre-Take-off Inspection

- Installation and component inspection
 1. Each module is installed correctly and firmly.
 2. The wiring of electric regulator and receiver shall be correct and firm.
- Inspection of working condition
 1. Whether the mode switch corresponds to the LED status indicator flashing.
 2. Check whether the working status indicator of GNSS-Compass flashes correctly.
 3. Check whether the sensor parameters are normal and calibrate according to the prompt.
 4. Shake the helicopter before takeoff to check that it is always level and correct.

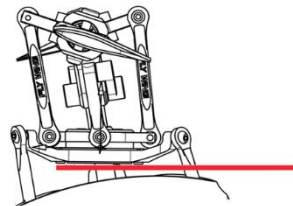
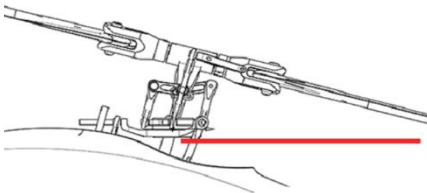

Safety Summary

Users are strongly encouraged to enjoy flying in a safe and reasonable environment. The necessary knowledge of flight safety is important for your safety and the safety of the people and environment around you. The user should ensure that there is a sufficient level of knowledge of the helicopter and that all emergency operations are known.

1. Environment

- Fly in open spaces away from people, traffic roads, ground facilities, property, airports, other aircraft or obstacles.
- Flight altitude is limited by aircraft performance. High-altitude conditions may reduce battery and powertrain efficiency, leading to performance degradation. Understand your aircraft's capabilities and fly cautiously.
- The flight control system operates within an ambient temperature range of -10°C to 55°C (non-direct sunlight conditions).
- Fly only in favorable weather (no rain, strong winds, or extreme conditions), during daylight or under well-lit conditions.
- Fly within legally permitted zones.

2. Inspection

- Ensure all devices are fully charged.
- Ensure that the propeller is not damaged and installed securely.
- Ensure that the helicopter components are clean and undamaged.
- Ensure that all modules of the flight control system are installed firmly and do not directly contact other metals and conductive materials; The installation position and orientation shall be correct; The connection shall be normal and firm, each plug shall be free of looseness, and the wire shall not be pulled by force when arranging and fixing the wire/plugging connector.

3. Operation

- Do not get close to the rotating propeller and motor.
- Fly within the visual range of the unaided eye.
- Do not transport dangerous and prohibited goods.
- Do not get close to the rotating propeller and motor.
- Fly within the visual range of the unaided eye.
- Turning the CH7 motor control switch during flight will cause the helicopter to crash. Use this function only in an emergency.
- Do not make or receive phone calls or text messages during the flight, and do not operate the helicopter under the influence of alcohol or drugs.
- Please return as soon as possible in case of low battery (or low voltage) warning.
- When the helicopter automatically returns, it will not avoid obstacles by itself. If the remote control signal is normal, the helicopter can cancel the return flight through the remote controller.
- After landing, close the helicopter first and then turn off the remote controller to avoid loss of the remote controller signal, and start the return mode.
- It is forbidden to use this product to throw or emit any dangerous articles to buildings, people or animals.

4. Maintenance

- Check the status of each module of flight control system regularly.
- The flight control system is suitable for long-term storage in a dry environment of 5°C to 35°C, no heat source nearby, no vibration, no strong magnetic field and no strong electric field.
- Do not store in a high place to avoid accidental drop, which may cause damage to the equipment or abnormal operation.

5. Flight restrictions and local regulations

- It is strictly prohibited to fly in the restricted area.
- It is recommended to control the flight altitude below 120m and strictly observe the local laws and regulations when flying.

Disclaimer and Warning

This product is not a toy and is not suitable for use by persons under the age of 18. Do not allow children to come into contact with this product and take special care when operating in the presence of children.

Read this document carefully before using this product. This statement has an important impact on the safe use of this product and your legal rights.

This product is a helicopter flight control system, which will provide safe and reliable flight control under the condition that the power supply works normally and all components are not damaged. Visit <http://www.flywingrc.com> for the latest instructions and warnings. Flywing reserves the right to update this disclaimer. Please refer to the version received at www.flywingrc.com for the latest disclaimer.

Be sure to read this document carefully before using the product to understand your legal rights, responsibilities and safety instructions; Otherwise, it may cause property loss, safety accident and personal safety hazard. By using this product, you are deemed to have understood, acknowledged and accepted all terms and contents of this statement. The user undertakes to be responsible for his own actions and all consequences arising therefrom. The user undertakes to use this product only for proper purposes and agrees to these terms and any relevant policies or guidelines that Flywing may have.

To the maximum extent permitted by law, in no event shall flywing be liable for any indirect, consequential, punitive, incidental, special or punitive damages, including damages arising out of your purchase, use or inability to use this product, even if flywing has been advised of the possibility of such damages.

In compliance with laws and regulations, flying wing aviation has the right to the final interpretation of the above terms. Flying Wing Aviation reserves the right to update, revise or terminate the provisions of this notice without prior notice. This notice is valid for a long time until the download service of this guide is terminated.

Appendices

How to switch the sticks modes (M1/M2)

The system has 4 stick modes . Long press the screen lock icon to unlock the screen, then click on the wrench icon to enter settings, and click on SYSTEM to find the Stick Mode option. Change the mode touch M1, 2, 3 or 4 on the right hand side of the screen. The currently selected mode is highlighted in black.

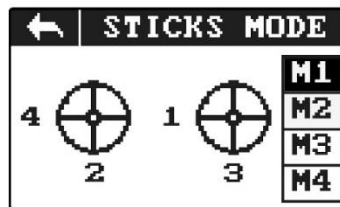
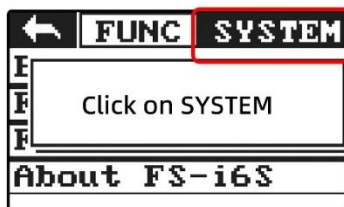

Advanced Parameter Explanations

The user is strongly advised not to change the value of this page, which has been debugged when it leaves the factory.

- 1、Throttle: This is the percentage of helicopter blade speed value.
- 2、Pitch gain: This is the correction gain of helicopter forward and backward.
- 3、Roll gain: This is the corrected gain of the helicopter for left and right translation.
- 4、Tail gain: this is the correction gain of helicopter left and right rotation.

5、 Brake gain: This is the force with which the helicopter brakes and hovers when the rocker is released after the helicopter moves.

LED flight status indicator

Mode	Flight Controller LED Status	External Left LED Status	External Right LED Status	Content
GPS Mode	● — — —	● — — —	● — — —	Locked Status, Acquiring GPS Positioning
	● — — —	● — — —	● — — —	GPS Positioning Acquired - Ready to Unlock
	● — — —	● ● — — —	● ● — — —	Unlocked Status
	● ● — — —	● ● — — —	● ● — — —	Battery Voltage Abnormal
ATTitude Mode	● — — —	● — — —	● — — —	Locked - Ready to Unlock
	● — — —	● ● — — —	● ● — — —	Unlocked Status
	● ● — — —	● ● — — —	● ● — — —	Battery Voltage Abnormal
RTH Mode	● — — —	● — — —	● — — —	RTL (Return-to-Launch) Mode
Compass Calibration	● ● — — —	● — — — — —	● — — — — —	Calibration Progress: 0-25%
	● — — — — —	● — — — — —	● — — — — —	Calibration Progress: 25-50%
	● — — — — —	● — — — — —	● — — — — —	Calibration Progress: 50-75%
	● — — — — —	● — — — — —	● — — — — —	Calibration Progress: 75-99%
	● — — — — —	● — — — — —	● — — — — —	Calibration Complete
Fault Status	● — — — — —	● — — — — —	● — — — — —	Acceleration Abnormal
	● — — — — —	● — — — — —	● — — — — —	Compass Abnormal
	● — — — — —	● — — — — —	● — — — — —	Transmitter Abnormal
	● — — — — —	● — — — — —	● — — — — —	Low Battery Level 1/2 Alert
	● ● — — —	● ● — — —	● ● — — —	Battery is below 75% / Other Anomalies



Flicker Velocity Interpretation

- — — — Slow flash, about once a second.
- — — — — — Fast flash, about every quarter of a second.
- — — — — — Quick flashes, very fast flashes.
- — — — — — Normally lit.

Accessory Information Table

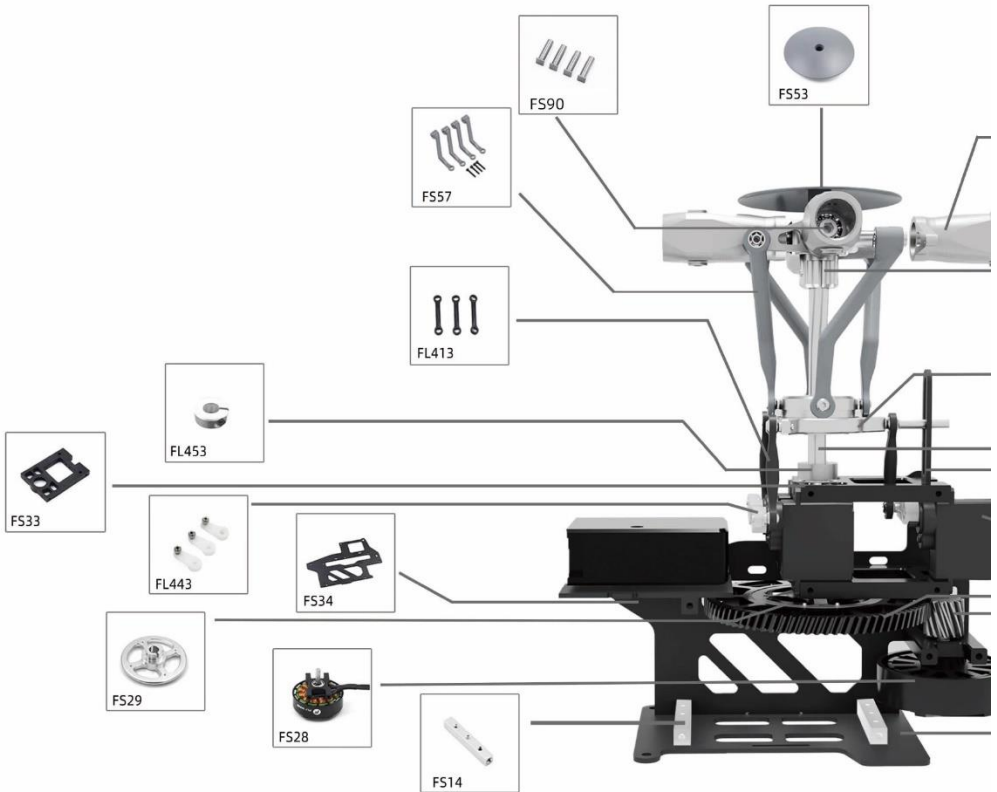

Accessory Name

FS08	Main Shaft	FS33	Main Shaft Mount
FS14	Aluminum Column	FS34	Side Frame Plate
FS73	Quick 4 Blade Rotor	FS35	Bottom Plate
FS28	Main Motor	FS36	Anti Rotation Bracket
FS29	Main Gear Fixed Plate	FS37	Controller Installed Plate
FS57	Long DFC Pitch Linkage	FS77	Landing Skid
FS52	4 Blade Swashplate Set	FS39	60A Scale ESC

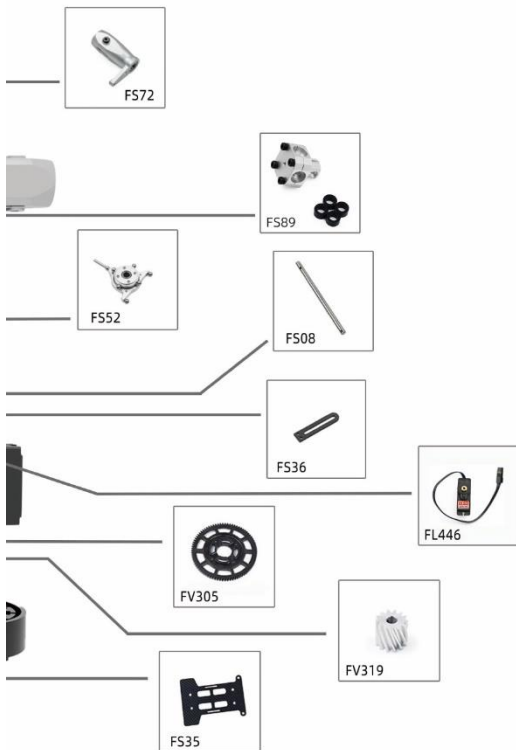

FS41 Tail Motor
 FS72 Rotor Holder
 FS53 Rotor Hub Cap
 FS89 Main Rotor Housing
 FS90 Feather Shaft
 FL446 H041 Servo
 FL453 Main Shaft Fixed

FV305 Main Gear
 FS84 Tail Blade
 FV319 Motor Gear
 FL413 Swashplate Linkage Rod Set
 FL443 H041 Servo Arm



This manual is subject to updates without prior notice.

Latest User Manual on the official FLYWING website

<http://www.flywingrc.com>

If you have any suggestions, you can leave us a message on the official website.

FLYWING All Rights Reserved